

shinjini dhar halder 9051887528 mail - dhar.shinjini@gmail.com

UNIT I: Bioenergetics:- Concept of free energy, endergonic and exergonic reaction, Relationship between free energy, enthalpy and entropy; Redox potential: Energy rich compounds; classification; biological significances of ATP and cyclic AMP

❖ Bioenergetics

• Defination

- Bioenergetics means study of the transformation of energy in living organisms.
- The goal of bioenergetics is to describe how living organisms acquire and transform energy in order to perform biological work. The study of metabolic pathways is thus essential to bioenergetics.
- In a living organism, chemical bonds are broken and made as part of the exchange and transformation of energy. Energy is available for work (such as mechanical work) or for other processes (such as chemical synthesis and anabolic processes in growth), when weak bonds are broken and stronger bonds are made. The production of stronger bonds allows release of usable energy.
- Adenosine triphosphate (ATP) is the main "energy currency" for organisms; the goal of metabolic and catabolic processes are to synthesize ATP from available starting materials (from the environment), and to break- down ATP (into adenosine diphosphate (ADP) and inorganic phosphate) by utilizing it in biological processes.
- In a cell, the ratio of ATP to ADP concentrations is known as the "*energy charge*" of the cell.
- A cell can use this energy charge to relay information about cellular needs; if there is more ATP than ADP available, the cell can use ATP to do work, but if there is more ADP than ATP available, the cell must synthesize ATP via oxidative phosphorylation.
- Living organisms produce ATP from energy sources via oxidative phosphorylation. The terminal phosphate bonds of ATP are relatively weak compared with the stronger bonds formed when ATP is hydrolyzed (broken down by water) to adenosine diphosphate and inorganic phosphate. Here it is the thermodynamically favorable free energy of hydrolysis that results in energy release; the phosphoanhydride bond between the terminal phosphate group and the rest of the ATP molecule does not itself contain this energy.

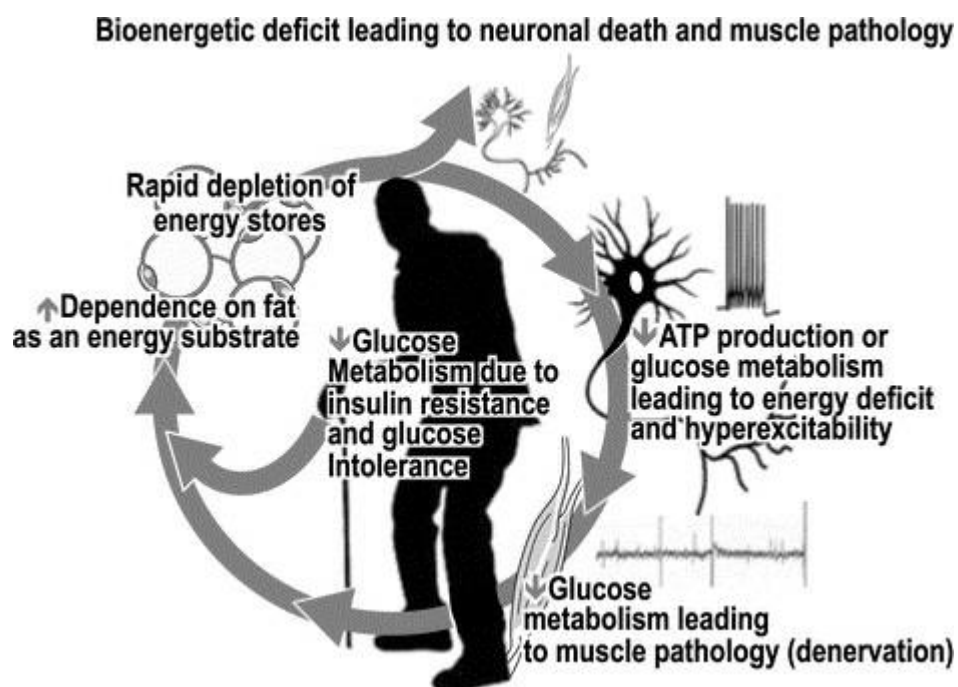

[Type here]

• Types of Bioenergetics Reactions

1. Exergonic Reaction

- Exergonic implies the release of energy from a spontaneous chemical reaction without any concomitant utilization of energy.
- The reactions are significant in terms of biology as these reactions have an ability to perform work and include most of the catabolic reactions in cellular respiration.
- Most of these reactions involve the breaking of bonds during the formation of reaction intermediates as is evidently observed during respiratory pathways. The bonds that are created during the formation of metabolites are stronger than the cleaved bonds of the substrate.
- The release of free energy, G , in an exergonic reaction (at constant pressure and temperature) is denoted as

$$\Delta G = G_{\text{products}} - G_{\text{reactants}} < 0$$

2. Endergonic Reactions

- Endergonic in turn is the opposite of exergonic in being non-spontaneous and requires an input of free energy. Most of the anabolic reactions like photosynthesis and DNA and protein synthesis are endergonic in nature.
- The release of free energy, G , in an exergonic reaction (at constant pressure and temperature) is denoted as

$$\Delta G = G_{\text{products}} - G_{\text{reactants}} > 0$$

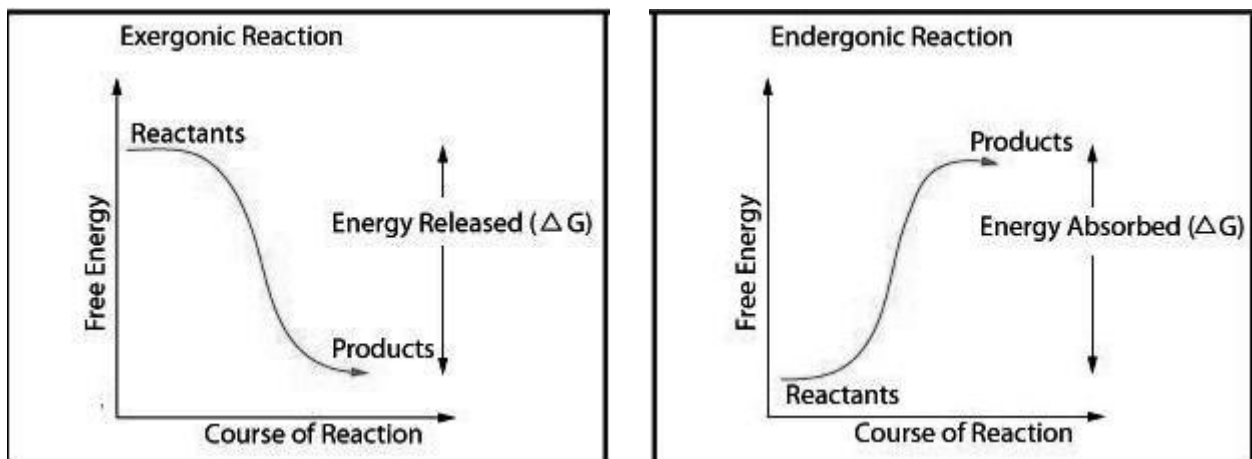

3. Activation Energy

- Activation energy is the energy which must be available to a chemical system with potential reactants to result in a chemical reaction. Activation energy may also be defined as the minimum energy required starting a chemical reaction.

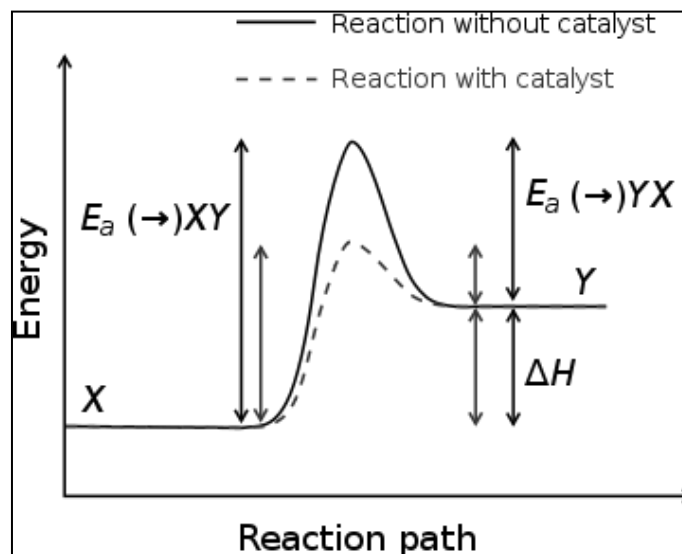

• **Examples of Major Bioenergetics Processes**

- ✓ **Glycolysis** is the process of breaking down glucose into pyruvate, producing net eight molecules of ATP (per 1 molecule of glucose) in the process. Pyruvate is one product of glycolysis, and can be shuttled into other metabolic pathways (gluconeogenesis, etc.) as needed by the cell. Additionally, glycolysis produces equivalents in the form of NADH (nicotinamide adenine dinucleotide), which will ultimately be used to donate electrons to the electron transport chain.
- ✓ **Gluconeogenesis** is the opposite of glycolysis; when the cell's energy charge is low (the concentration of ADP is higher than that of ATP), the cell must synthesize glucose from carbon- containing biomolecules such as proteins, amino acids, fats, pyruvate, etc. For example, proteins can be broken down into amino acids, and these simpler carbon skeletons are used to build/ synthesize glucose.
- ✓ **The citric acid cycle** is a process of cellular respiration in which acetyl coenzyme A, synthesized from pyruvate dehydrogenase, is first reacted with oxaloacetate to yield citrate. The remaining eight reactions produce other carbon- containing metabolites. These metabolites are successively oxidized, and the free energy of oxidation is conserved in the form of the reduced coenzymes FADH₂ and NADH. These reduced electron carriers can then be re- oxidized when they transfer electrons to the electron transport chain.
- ✓ **Ketosis** is a metabolic process whereby ketone bodies are used by the cell for energy (instead of using glucose). Cells often turn to ketosis as a source of energy when glucose levels are low; e.g. during starvation.
- ✓ **Oxidative phosphorylation** and the **electron transport chain** is the process where reducing equivalents such as NADPH, FADH₂ and NADH can be used to donate electrons to a series of redox reactions that take place in electron transport chain complexes. These redox reactions take place in enzyme complexes situated within the mitochondrial membrane. These redox reactions transfer electrons "down" the electron transport chain, which is coupled to the proton motive force. This difference in proton concentration between the mitochondrial matrix and inner membrane space is used to drive ATP synthesis via ATP synthase.
- ✓ **Photosynthesis**, another major bioenergetic process, is the metabolic pathway used by plants in which solar energy is used to synthesize glucose from carbon dioxide and water. This reaction takes place in the chloroplast. After glucose is synthesized, the plant cell can undergo photophosphorylation to produce ATP.

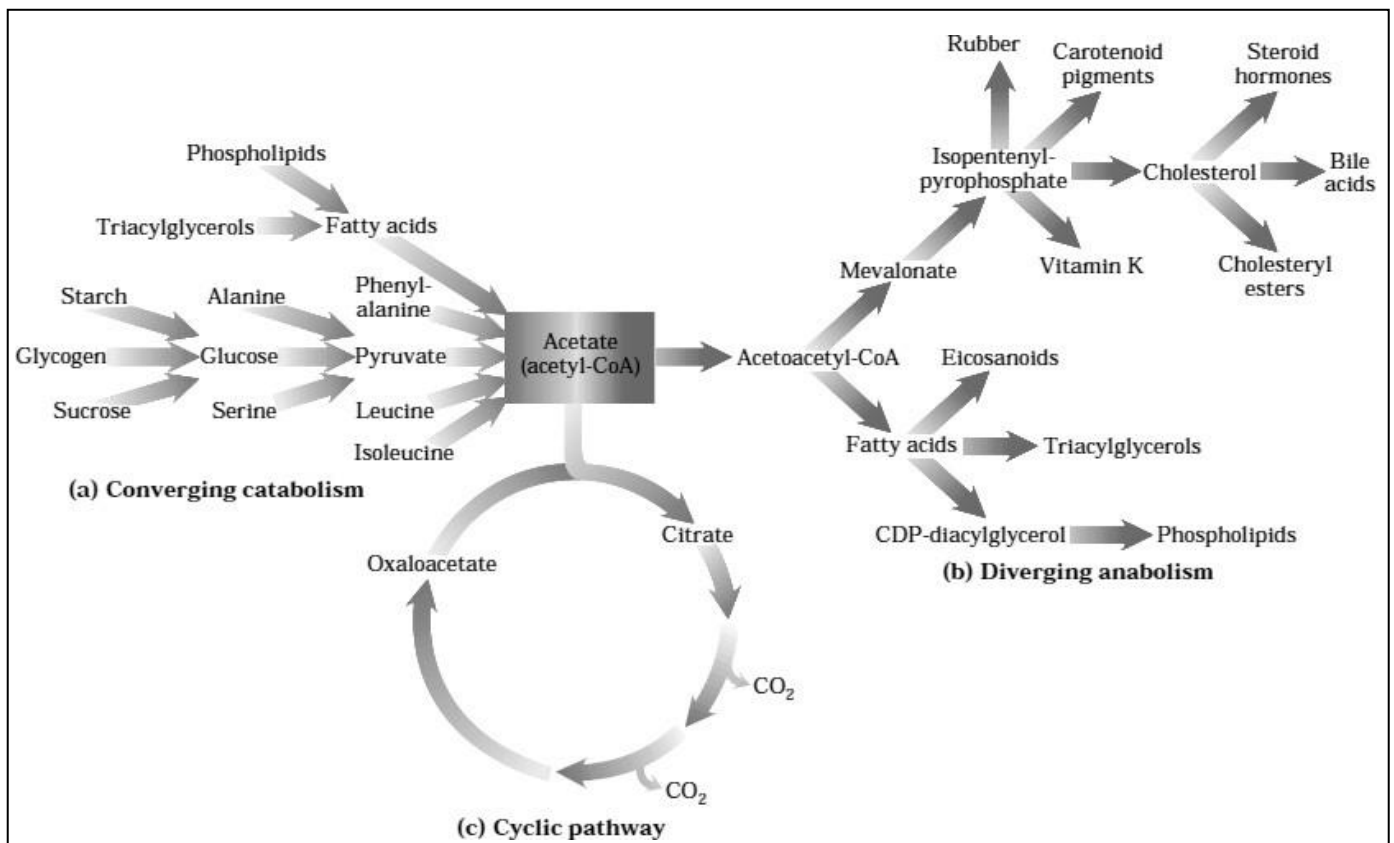

❖ Bioenergetics Relationship Between Free Energy, Enthalpy & Entropy

- Every living cell and organism must perform work to stay alive, to grow and to reproduce. The ability to harvest energy from nutrients or photons of light and to channel it into biological work is the miracle of life.
- **1st Law of Thermodynamics:** The energy of the universe remains constant.
- **2nd Law of Thermodynamics:** All spontaneous processes increase the entropy of the universe.
- The important state functions for the study of biological systems are:
 - ✓ **The Gibbs free energy (G)** which is equal to the total amount of energy capable of doing work during a process at constant temperature and pressure.
 - If ΔG is negative, then the process is spontaneous and termed exergonic.
 - If ΔG is positive, then the process is nonspontaneous and termed endergonic.
 - If ΔG is equal to zero, then the process has reached equilibrium.
 - ✓ **The Enthalpy (H)** which is the heat content of the system. Enthalpy is the amount of heat energy transferred (heat absorbed or emitted) in a chemical process under constant pressure.
 - When ΔH is negative the process produces heat and is termed exothermic.
 - When ΔH is positive the process absorbs heat and is termed endothermic.
 - ✓ **The Entropy (S)** is a quantitative expression of the degree of randomness or disorder of the system. Entropy measures the amount of heat dispersed or transferred during a chemical process.
 - When ΔS is positive then the disorder of the system has increased.
 - When ΔS is negative then the disorder of the system has decreased.
- The conditions of biological systems are constant temperature and pressure. Under such conditions the relationships between the change in free energy, enthalpy and entropy can be described by the expression where T is the temperature of the system in Kelvin. $\Delta G = \Delta H - T\Delta S$
[$\Delta G =$ Gibbs Free Energy; $\Delta H =$ Change in Enthalpy; $T =$ Temperature in K; $\Delta S =$ Change in Entropy]

Quantity	Symbol	Measures	Units
Enthalpy	H	Heat	Energy
Entropy	S	Disorder	Energy/K
Free energy	G	Reactivity	Energy

❖ Energy Rich Compounds

- High energy phosphates act as energy currency of cell.
- Three major sources of high energy phosphates taking part in energy conservation or energy capture.

1. Oxidative phosphorylation (or OXPHOS in short)

- In metabolic pathway, cells use enzymes to oxidize nutrients, thereby releasing energy which is used to produce adenosine triphosphate (ATP). In most eukaryotes, this takes place inside mitochondria. Almost all aerobic organisms carry out oxidative phosphorylation. This pathway is probably so pervasive because it is a highly efficient way of releasing energy, compared to alternative fermentation processes such as anaerobic glycolysis.
- The process that accounts for the high ATP yield is known as **oxidative phosphorylation**.
- In glycolysis and the citric-acid cycle generate other products besides ATP and GTP, namely NADH and FADH₂. These products are molecules that are oxidized (i.e., give up electrons) spontaneously. The body uses these reducing agents (NADH and FADH₂) in an oxidation-reduction reaction

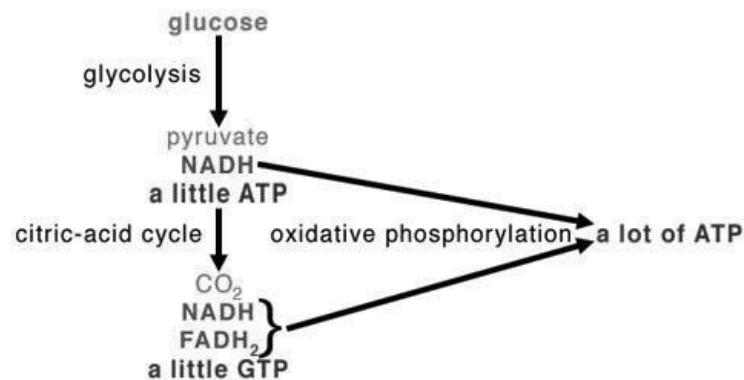

2. Glycolysis:

- Cells use the glycolysis pathway to extract energy from sugars, mainly glucose, and store it in molecules of adenosine triphosphate (ATP) and nicotinamide adenine dinucleotide (NADH). The end product of glycolysis is pyruvate, which can be used in other metabolic pathways to yield additional energy.
- During glycolysis ATP molecules are used and formed in the following reactions (aerobic phase).

<i>Reactions Catalyzed</i>	<i>ATP used</i>	<i>ATP formed</i>
Stage I:		
1. Glucokinase (for phosphorylation)	1	
2. Phosphofruktokinase I (for phosphorylation)	1	
Stage II:		
3. Glyceraldehyde 3-phosphate dehydrogenase (oxidation of 2 NADH in respiratory chain)		6
4. Phosphoglycerate kinase (substrate level phosphorylation)		2
Stage IV:		
5. Pyruvate kinase (substrate level phosphorylation)		2
Total	2	10
Net gain		08

- In the anaerobic phase oxidation of one glucose molecule produces $4 - 2 = 2$ ATP.

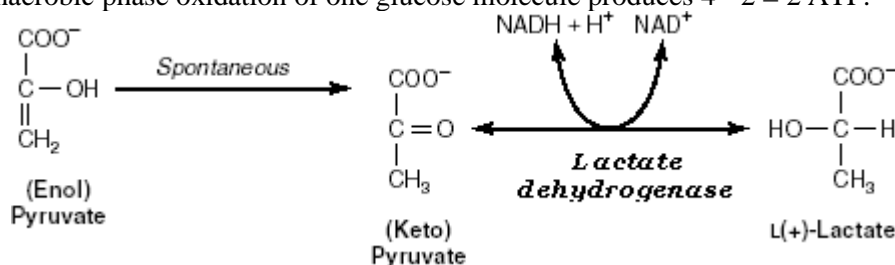

[Type here]

3. TCA Cycle

- The citric acid cycle (CAC) – also known as the tricarboxylic acid (TCA) cycle or the Krebs cycle is a series of chemical reactions used by all aerobic organisms to release stored energy through the oxidation of acetyl-CoA derived from carbohydrates, fats, and proteins into carbon dioxide and chemical energy in the form of adenosine triphosphate (ATP).
- If one molecule of the substrate is oxidized through NADH in the electron transport chain three molecules of ATP will be formed and through FADH₂, two ATP molecules will be generated. As one molecule of glucose gives rise to two molecules of pyruvate by glycolysis, intermediates of citric acid cycle also result as two molecules.

Reactions	No.of ATP formed
1. 2 isocitrate → 2 α-ketoglutarate (2 NADH + 2H ⁺) (2 × 3)	6
2. 2 α-ketoglutarate → 2 succinyl CoA (2 NADH + 2H ⁺) (2 × 3)	6
3. 2 succinyl CoA → 2 succinate (2 GTP = 2ATP)	2
4. 2 succinate → 2 Fumarate (2 FADH ₂) (2 × 2)	4
5. 2 malate → 2 oxaloacetate (2 NADH + 2H ⁺) (2 × 3)	6
Total No.of ATP formed	24

- **Energy shuttles:**

- i. NADH:** An energy shuttle which delivers high energy electrons to the electron transport chain where they will eventually power the production of 2 to 3 **ATP** molecules. When this electron shuttle is not carrying high energy electrons, meaning it has been oxidized (lost its electrons), it is left with a positive charge and is called **NAD⁺**.
- ii. FADH₂:** Another energy shuttle that carries high energy electrons to the electron transport chain, where they will ultimately drive production of 1 to 2 **ATP** molecules. The oxidized form of **FADH₂** is **FAD** and happens just like in **NADH**.

High energy molecules:

- iii. ATP:** The basic energy currency of the cell. It's a form of energy that cells can use right away.
- iv. GTP:** Similar to **ATP**, **GTP** can be easily converted to **ATP** in the cell.

4. Energy Released by Hydrolysis of Some Phosphate Compounds

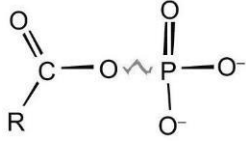
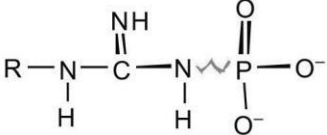
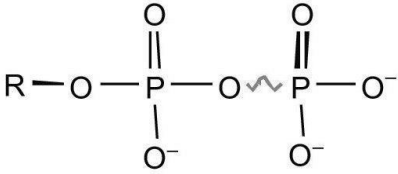
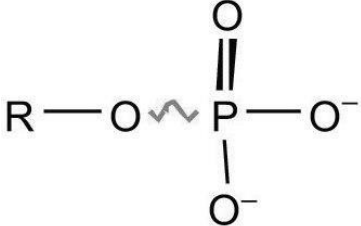
Type	Example	Energy Released (kcal/mol)
<i>acyl phosphate</i> 	1,3-bisphosphoglycerate (BPG)	-11.8
	acetyl phosphate	-11.3
<i>guanidine phosphates</i> 	creatine phosphate	-10.3
	arginine phosphate	-9.1
<i>pyrophosphates</i> 	PP _i * → 2P _i	-7.8
	ATP → AMP + PP _i	-7.7
	ATP → ADP + P _i	-7.5
	ADP → AMP + P _i	-7.5
<i>sugar phosphates</i> 	glucose 1-phosphate	-5.0
	fructose 6-phosphate	-3.8
	AMP → adenosine + P _i	-3.4
	Glucose-6-phosphate	-3.3
	Glycerol-3-phosphate	-2.2

*PP_i is the pyrophosphate ion.

ATP - LIKE A RECHARGEABLE BATTERY



[Type here]

❖ ADENOSINE TRIPHOSPHATE (ATP)

- ✓ Adenosine-5'-triphosphate (ATP) is a multifunctional nucleotide used in cells as a coenzyme.
- ✓ It is often called the "molecular unit of currency" of intracellular energy transfer. ATP transports chemical energy within cells for metabolism.
- ✓ It is produced by photophosphorylation and cellular respiration and used by enzymes and structural proteins in many cellular processes, including biosynthetic reactions, motility, and cell division.
- ✓ One molecule of ATP contains three phosphate groups and it is produced by *ATP synthase* from inorganic phosphate and adenosine diphosphate (ADP) or adenosine monophosphate (AMP).
- ✓ The structure of this molecule consists of a purine base (adenine) attached to the 1' carbon atom of a pentose sugar (ribose). Three phosphate groups are attached at the 5' carbon atom of the pentose sugar. It is the addition and removal of these phosphate groups that inter-convert ATP, ADP and AMP. When ATP is used in DNA synthesis, the ribose sugar is first converted to deoxyribose by *ribonucleotide reductase*.

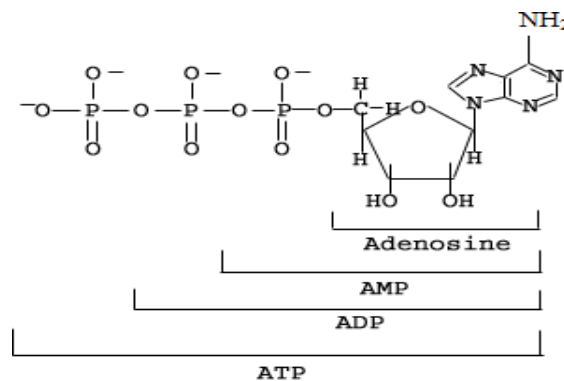

- ✓ The three main functions of ATP in cellular function are:
 1. Transporting organic substances—such as sodium, calcium, potassium—through the cell membrane.
 2. Synthesizing chemical compounds, such as protein and cholesterol.
 3. Supplying energy for mechanical work, such as muscle contraction.
- ✓ The standard amount of energy released from hydrolysis of ATP can be calculated from the changes in energy under non-natural (standard) conditions, then correcting to biological concentrations. The energy released by cleaving either a phosphate (P_i) or pyrophosphate (PP_i) unit from ATP at standard state of 1 M are:

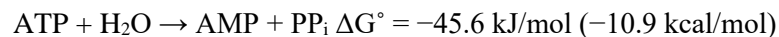
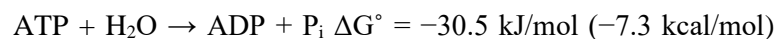

These values can be used to calculate the change in energy under physiological conditions and the cellular ATP/ADP ratio (also known as the Energy Charge). This reaction is dependent on a number of factors, including overall ionic strength and the presence of alkaline earth metal ions such as Mg^{2+} and Ca^{2+} . Under typical cellular conditions, ΔG is approximately -57 kJ/mol (-14 kcal/mol).

❖ CYCLIC ADENOSINE MONOPHOSPHATE (cAMP, cyclic AMP or 3'-5'-cyclic adenosine monophosphate)

- ✓ It is a second messenger important in many biological processes. cAMP is derived from adenosine triphosphate (ATP) and used for intracellular signal transduction in many different organisms, conveying the cAMP-dependent pathway.
- ✓ cAMP is synthesised from ATP by adenylyl cyclase located on the inner side of the plasma membrane. *Adenylyl cyclase* is activated by a range of signaling molecules through the activation of *adenylyl cyclase* stimulatory G (G_s)-protein-coupled receptors and inhibited by agonists of *adenylyl cyclase* inhibitory G (G_i)-protein-coupled receptors. Liver *adenylyl cyclase* responds more strongly to glucagon, and muscle adenylyl cyclase responds more strongly to adrenaline.
- ✓ cAMP decomposition into AMP is catalyzed by the enzyme *phosphodiesterase*.
- ✓ **Function:** cAMP is a second messenger, used for intracellular signal transduction, such as transferring the effects of hormones like glucagon and adrenaline, which cannot pass through the cell membrane. It is involved in the activation of *protein kinases* and regulates the effects of adrenaline and glucagon. It also regulates the passage of Ca^{2+} through ion channels. cAMP and its associated kinases function in several biochemical processes, including the regulation of glycogen, sugar, and lipid metabolism by activating protein kinase

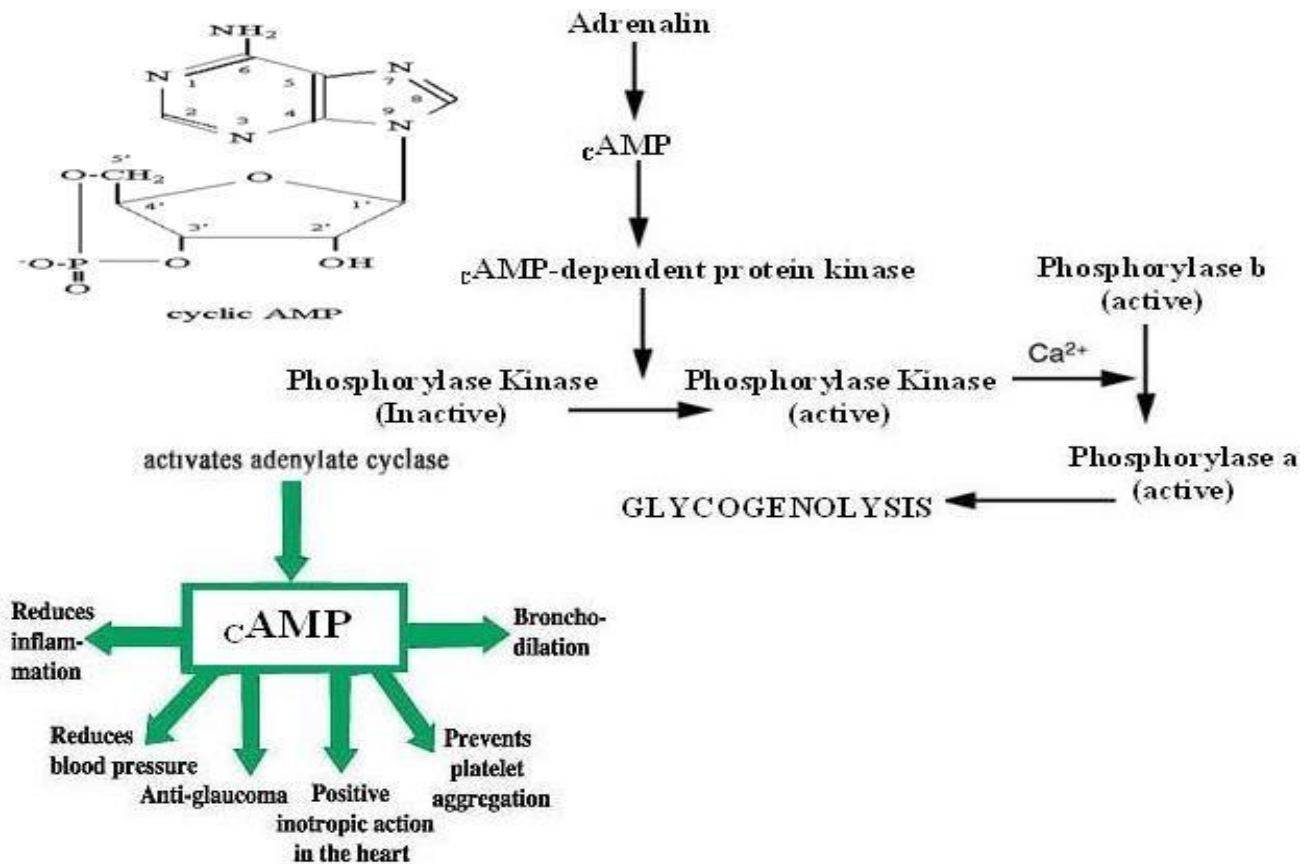

❖ GUANOSINE TRIPHOSPHATE (GTP)

- Guanosine-5'-triphosphate (GTP) is a purine nucleoside triphosphate. It can act as a substrate for both the synthesis of RNA during the transcription process and of DNA during DNA replication.
- It also has the role of a source of energy or an activator of substrates in metabolic reactions, like that of ATP, but more specific. It is used as a source of energy for protein synthesis and gluconeogenesis.
- GTP is essential to signal transduction, in particular with G-proteins, in second-messenger mechanisms where it is converted to **Guanosine diphosphate (GDP)** through the action of GTPases.
- **USES:**
 - ✓ **Energy transfer**
 - GTP is involved in energy transfer within the cell. For instance, a GTP molecule is generated by one of the enzymes in the citric acid cycle. This is tantamount to the generation of one molecule of ATP, since GTP is readily converted to ATP with nucleoside-diphosphate kinase (NDK).
 - ✓ **Genetic translation**
 - During the elongation stage of translation, GTP is used as an energy source for the binding of a new amino-bound tRNA to the A site of the ribosome.
 - ✓ **Mitochondrial function**
 - The translocation of proteins into the mitochondrial matrix involves the interactions of both GTP and ATP.
- **Synthesis of AMP and GMP from IMP.**

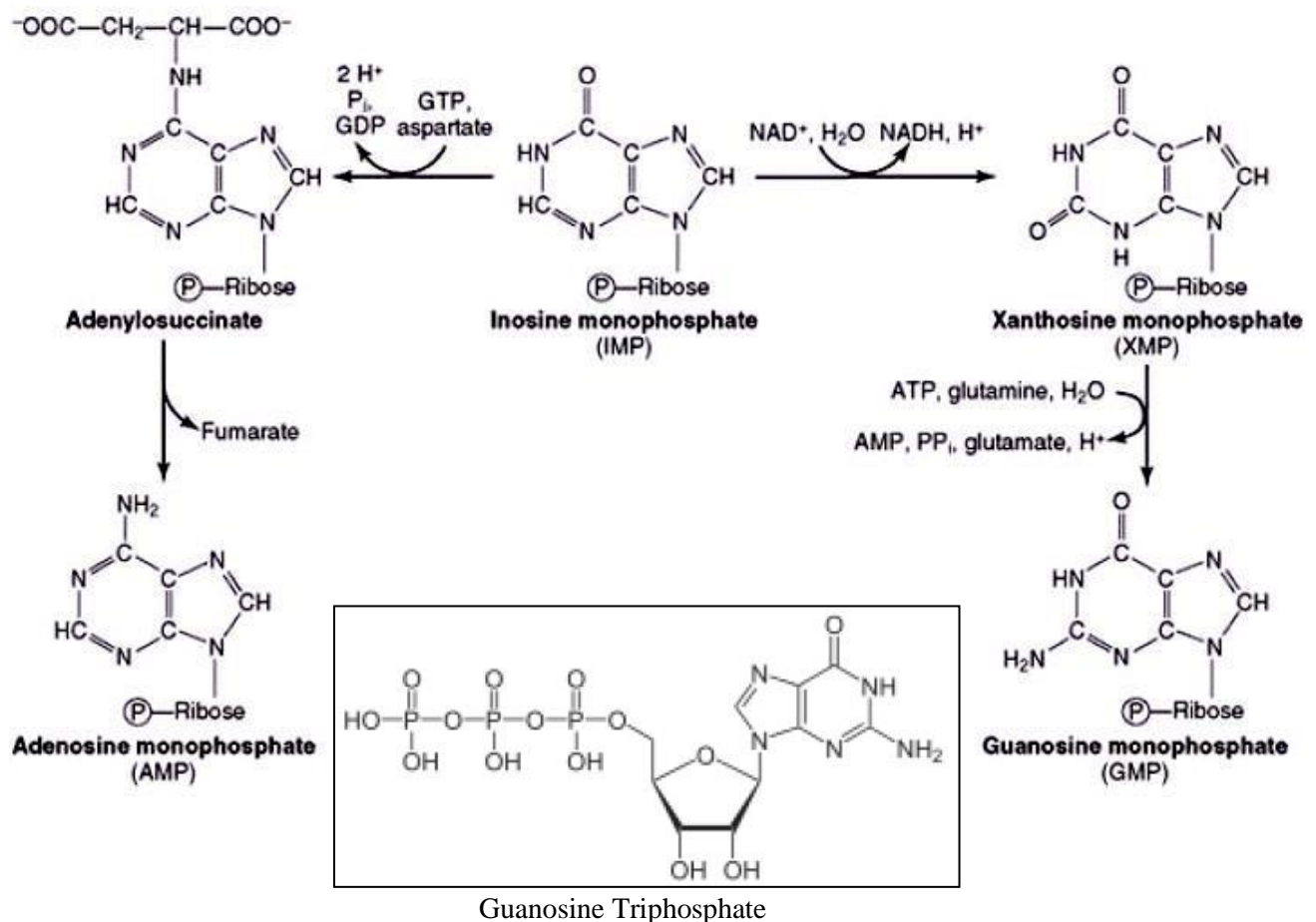

❖ Cyclic Guanosine Monophosphate

- Cyclic guanosine monophosphate (**cGMP**) is a cyclic nucleotide derived from guanosine triphosphate (GTP).
- cGMP acts as a second messenger much like cyclic AMP. Its most likely mechanism of action is activation of intracellular protein kinases in response to the binding of membrane-impermeable peptide hormones to the external cell surface.
- **Synthesis:** Guanylate cyclase (GC) catalyzes cGMP synthesis. This enzyme converts GTP to cGMP.

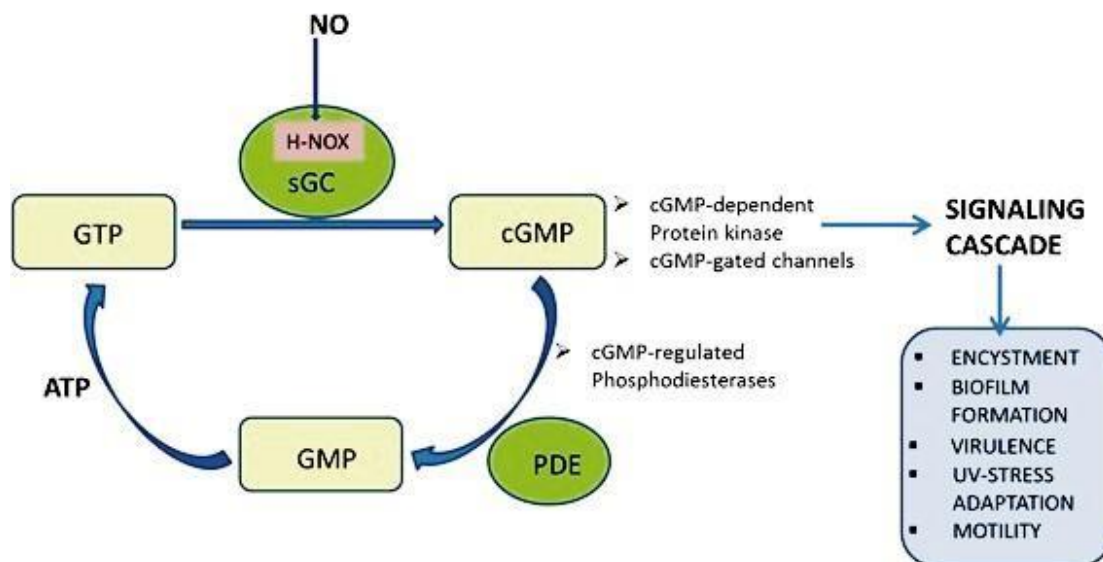

Schematic representation of synthesis, degradation, and function of cGMP. The three targets of cGMP molecules are (i) cGMP dependent protein kinases, (ii) cGMP gated ion channels and (iii) cGMP-dependent phosphodiesterases. While phosphodiesterases are involved in the degradation of cGMP to GMP, the protein kinases and activation of ion channels are subsequently involved in various bacterial signaling pathways. GTP: Guanosine 5'-triphosphate; sGC: soluble guanylate cyclase; NO: nitric oxide; H-NOX: Heme-Nitric oxide/Oxygen domain; cGMP: cyclic guanosine 3',5'-monophosphate; PDE: Phosphodiesterase; GMP: guanosine 3',5'-monophosphate; ATP: adenosine 5'-triphosphate.

- Effects

- cGMP is a common regulator of ion channel conductance, glycogenolysis, and cellular apoptosis. It also relaxes smooth muscle tissues. In blood vessels, relaxation of vascular smooth muscles leads to vasodilation and increased blood flow.
- cGMP is a secondary messenger in phototransduction in the eye.
- cGMP is involved in the regulation of some protein-dependent kinases.

